



LATITUDE

HD

SRL Manual



WARNING

This product is part of a personal fall arrest, work positioning, or rescue system. The manufacturer's instructions must be provided to users of this equipment. The user must follow the manufacturer's instructions for each component of the system. The user must read and understand these instructions before using this equipment. Manufacturer's instructions must be followed for proper use and maintenance of this equipment. Alterations to this product, misuse of this product, or failure to follow instructions may result in serious injury or death.



IMPORTANT

Questions regarding the use, care, or suitability of this equipment for your application? Contact Safewaze.



IMPORTANT

Record identification information before using this product. Identification information may be found on the equipment label. This information should be recorded in the "Inspection and Maintenance Log" located on (Page 20) of this manual. Annual inspections by a Competent Person other than the user must be recorded in the Inspection Log on (Page 22) of this manual.

ANSI Z359.14 and ANSI/ASSE A10.32
This manual is intended to meet the manufacturer's instructions as required by ANSI Z359.14 and should be used as part of an employee training program as required by OSHA.

**TABLE 1 - PART NUMBERS AND CONFIGURATIONS
COVERED IN THIS MANUAL**

Part Number	Length in Feet	Single Leg / Dual Leg	Material	Housing	Sewn In Fall Indicator	Energy Absorber (Indicator)	3/4" Steel Swivel Fall Indicating Snaphook	3/4" Steel Tie-Back Snaphook	3/4" Steel Snaphook	3/4" Aluminum Snaphook	1.75" Steel Rebar Hook	1.75" Aluminum Rebar Hook	Dual Leg Bracket	Behind the Web Bracket	Carabiner
FS-FSP1211-G	11	SINGLE	CABLE	POLY			✓								✓
FS-FSP1211-G-RBH	11	SINGLE	CABLE	POLY									✓		✓
FS-FSP1407-W	7	SINGLE	WEB	ALU	✓			✓							✓
FS-FSP1407-W-RBH	7	SINGLE	WEB	ALU	✓								✓		✓
FS-FSP1407-W-TBH	7	SINGLE	WEB	ALU	✓					✓					✓
FS-FSP1409-W	9	SINGLE	WEB	ALU	✓			✓							✓
FS-FSP1409-W-DL	9	DUAL	WEB	ALU	✓			✓						✓	✓
FS-FSP1409-W-DL-BWB	9	DUAL	WEB	ALU	✓			✓						✓	✓
FS-FSP1409-W-DL-RBH	9	DUAL	WEB	ALU	✓								✓	✓	✓
FS-FSP1409-W-DL-RBH-BWB	9	DUAL	WEB	ALU	✓								✓	✓	✓
FS-FSP1409-W-RBH	9	SINGLE	WEB	ALU	✓								✓		✓
FS-FSP1411-W	11	SINGLE	WEB	ALU	✓			✓							✓
FS-FSP1411-W-RBH	11	SINGLE	WEB	ALU	✓								✓		✓
FS-FSP1411-W-TBH	11	SINGLE	WEB	ALU	✓					✓					✓
FS-FSP14075-W	7	DUAL	WEB	ALU	✓			✓						✓	✓
FS-FSP14075-W-TBH	7	DUAL	WEB	ALU	✓					✓				✓	✓
FS-FSP14085-W-RBH	7	DUAL	WEB	ALU	✓								✓	✓	✓
FS-FSP14095-W	11	DUAL	WEB	ALU	✓			✓						✓	✓
FS-FSP14095-W-RBH	11	DUAL	WEB	ALU	✓								✓	✓	✓
FS-FSP15075-W-BWB	7	DUAL	WEB	ALU	✓			✓						✓	✓
FS-FSP15085-W-RBH-BWB	7	DUAL	WEB	ALU	✓								✓		✓
SW8008-10	10	SINGLE	CABLE	POLY		✓		✓							✓
SW8008-10-ALU	10	SINGLE	CABLE	POLY		✓						✓			✓
SW8008-10-ALUDL	10	DUAL	CABLE	POLY		✓						✓			✓
SW8008-10-ALURBH	10	SINGLE	CABLE	POLY		✓							✓		✓
SW8008-10-ALURBHDL	10	DUAL	CABLE	POLY		✓							✓		✓
SW8008-10-DL	10	DUAL	CABLE	POLY		✓		✓							✓
SW8008-10-RBH	10	SINGLE	CABLE	POLY		✓							✓		✓
SW8008-10-RBHDL	10	DUAL	CABLE	POLY		✓							✓		✓

Descriptions

Table 1 indicates the SRL models included in the Latitude HD Series as well as their configurations. Standard web models in the series are offered in 7 ft (2.13 m), 9 ft (2.74 m), and 11 ft (3.35 m) lengths. Cable models are offered in 10 ft (3.04 m) and 11ft (3.35 m) lengths.

Safewaze Tie-Back SRL's contain 7 ft (2.13 m) Dyneema® webbing that retracts within the SRL housing. Tie-Back SRL's have an additional poly web Section that is 1.5 ft (0.46 m) long and is wrapped around an anchorage and tied back into itself. (See Figure 9)

Cable models are single leg (The SW-8008 series is available in a dual configuration), and can be mounted to a suitable anchor point overhead or worn attached to the dorsal back D-ring of the harness.

Web models come in single, dual, and Tie-Back options. Dual leg Safewaze SRL's can be mounted to a suitable anchor point overhead or worn attached to the dorsal D-ring of the harness or with a Behind the Web Bracket. Cable models that are available in a dual configuration are the SW-8008-10 series of SRL's.

SRL units extend and retract freely with normal movement. If a fall occurs the system locks automatically, arresting the fall, and keeps the worker from falling further.

1.0 Applications

1.1 Purpose

Safewaze Latitude HD SRL's are designed for use in environments where a fall could occur. The purpose is to prevent the fall or limit the potential fall arrest forces as much as possible. A variety of connection and configuration options are available to suit any users preference or jobsite requirements (See Figure 1). Applications include, but are not limited to: roofing, concrete, steel, MEP, industrial maintenance, and material handling.

FIGURE 1 - SRL TO HARNESS CONNECTION EXAMPLES

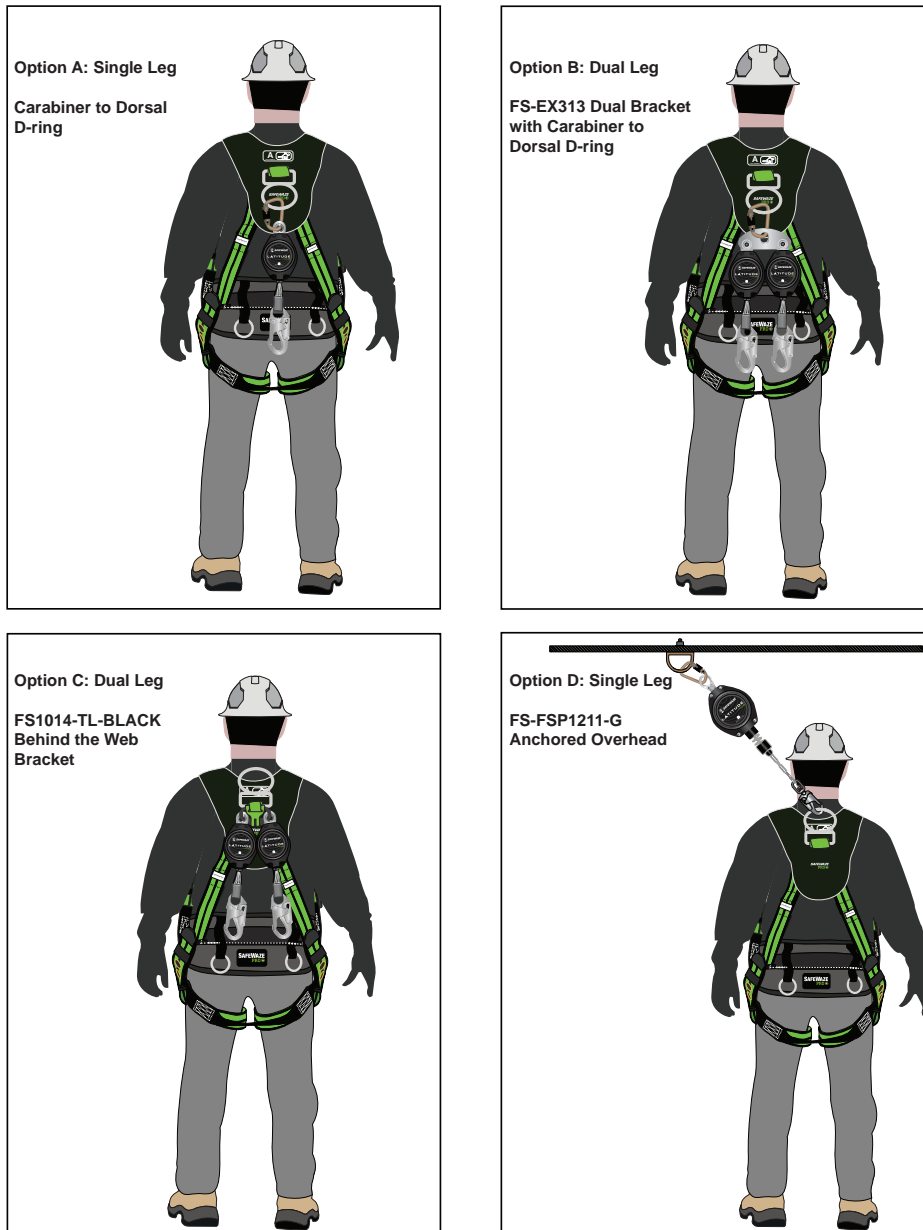

1.2 Standards

Safewaze SRL's conform to the national standard(s) identified on their ID label. Refer to local, state, and federal (OSHA) requirements for additional information concerning the governing of occupational safety regarding Personal Fall Arrest Systems (PFAS). Examples of Latitude HD SRL labeling are located on (Page 18) of this manual.

TABLE 2 - ANSI STANDARDS

ANSI	Z359.0	Definitions and Nomenclature Used for Fall Protection and Fall Arrest
ANSI	Z359.2	Minimum Requirements for a Comprehensive Managed Fall Protection Program
ANSI	Z359.12	Connecting Components for Personal Fall Arrest Systems
ANSI	Z359.14	Safety Requirements for Self-Retracting Devices for Personal Fall Arrest and Rescue Systems
ANSI	A10.32	Personal Fall Protection use in Construction and Demolition

1.3 Training

This equipment is intended to be used by persons trained in its correct application and use. It is the responsibility of the user to assure they are familiar with these instructions and are trained in the correct care and use of this equipment. Users must be aware of the operating characteristics, application, limits, and the consequences of improper use.

2.0 Limitations & Requirements

When installing or using this equipment always refer to the following requirements and limitations:

2.1 Capacity

Safewaze Retractable Fall Arresters are all designed in compliance with ANSI Z359.14 to meet the weight capacity range of (130-310 lbs), OSHA (420 lbs).

2.2 Anchorage

Anchorage selected for fall arrest systems shall have a strength capable of sustaining static loads applied in the directions permitted by the system of at least:

1. 5,000 lbs. (22.2 kN) for non-certified anchorages, or
2. Two times the maximum arresting force for certified anchorages.

When more than one fall arrest system is attached to an anchorage, the strengths set forth in (1) and (2) above shall be multiplied by the number of systems attached to the anchorage.

From OSHA 1926.500 and 1910.66

Anchorage used for attachment of personal fall arrest systems shall be independent of any anchorage being used to support or suspend platforms, and capable of supporting at least 5,000 lbs (22.2 kN) per user attached, or be designed, installed, and used as part of a complete personal fall arrest system which maintains a safety factor of at least two, and is under the supervision of a qualified person.

2.3 INSPECTION FREQUENCY

Either the Authorized Person¹ (User) or the Rescuer² must inspect this equipment prior to each use. The Inspection table (Table 3), should be used to determine proper inspection frequency. The Inspection Checklist (Page 20) describes proper inspection procedures. The Competent Person should record inspection results in the Maintenance Log (Page 21) of this manual. Annual inspections by a Competent Person other than the user must be recorded in the Inspection Log (Page 22).

1. **Authorized Person:** A person assigned by the employer to perform duties at a location where such person will be exposed to a fall hazard.
2. **Rescuer:** Person or persons other than the rescue subject acting to perform an assisted rescue by operation of a rescue system.

2.4 Rescue Plan

When using this equipment, employers must create a rescue plan, and provide the means to implement said rescue plan. This plan must be communicated to equipment users, authorized persons, and rescuers.



NOTE: Special rescue measures may be required for a fall over an edge.

TABLE 3 - INSPECTION SCHEDULE PER ANSI Z359.14

Type of Use	Application Examples	Conditions of Use	Inspection Frequency Competent Person
Infrequent to Light	Rescue and Confined Space, Factory Maintenance	Good Storage Conditions, Indoor or Infrequent Outdoor Use, Room Temperature, Clean Environments	Annually
Moderate to Heavy	Transportation, Residential Construction, Utilities, Warehouse	Fair Storage Conditions, Indoor and Extended Outdoor Use, All Temperatures, Clean or Dusty Environments	Semi-Annually to Annually
Severe to Continuous	Commercial Construction, Oil and Gas, Mining	Harsh Storage Conditions, Prolonged or Continuous Outdoor Use, All Temperatures, Dirty Environment	Quarterly to Semi- Annually

2.5 Locking Speed

The nature of this equipment requires sufficient space in the working area to allow for the SRL to lock. Working in small or confined spaces may keep the user's body from reaching the speed needed to lock the SRL during a fall. Working on slowly shifting materials, such as grain or sand, may not allow the speed needed to cause the SRL to lock.

2.6 Normal Operations

During normal operation the SRL lifeline should freely extend and retract without hesitation. When moving at normal speeds the lifeline will have no slack. A fall will activate the brake system and stop the fall. Avoid sudden or fast movements during normal operation as this may cause the SRL to lock.

2.7 Free Fall

In order to ensure reduced fall distances, always attempt to anchor the SRL directly overhead. Overhead anchoring will limit free fall distance to a minimum length. Be aware of workers sharing the workspace to avoid becoming tangled with another worker. Steer clear of objects that could fall and impact the lifeline. The lifeline should never pass under the user's arms or legs. The lifeline should never be knotted, clamped, or be otherwise restricted from retraction or a taut state.

2.8 Hazards

External hazards can require additional precautions to be taken when using this SRL. Hazards may include but are not limited to: Overhead operations, other equipment, other workers, external environment, weather and walking surface. Users should be trained to watch for other hazards not listed here.

2.9 Sharp Edges

Use of this equipment should be avoided in areas where the lifeline may come into contact with sharp, abrasive and/or leading edges unless otherwise noted.

2.10 Body Support

The SRL must be used with a Full Body Harness. The Full Body Harness must connect via the dorsal D-ring. Safewaze SRL's are not rated for use with a body belt. Use of Safewaze SRL's with a body belt may result in injury.

2.11 Fall Clearance

It is important to make sure that adequate clearance is available. An example of calculating your Minimum Required Fall Clearance is shown in (Figure 2).

2.12 Minimum Required Fall Clearance Latitude HD SRL's

FIGURE 2 - DETERMINING MINIMUM REQUIRED FALL CLEARANCE

Latitude HD SRL Minimum Required Fall Clearance		
A	2 ft	SRL Deceleration Distance
B	1 ft	Harness Stretch / D-ring Shift
C	1 ft	Safety Factor
D	4 ft	Sub-Total for Minimum Required Fall Clearance
E		*Additional Fall Clearance for Swing Fall (If swing fall hazard exists refer to Table 7, Page 13)
F		Total Fall Clearance Required

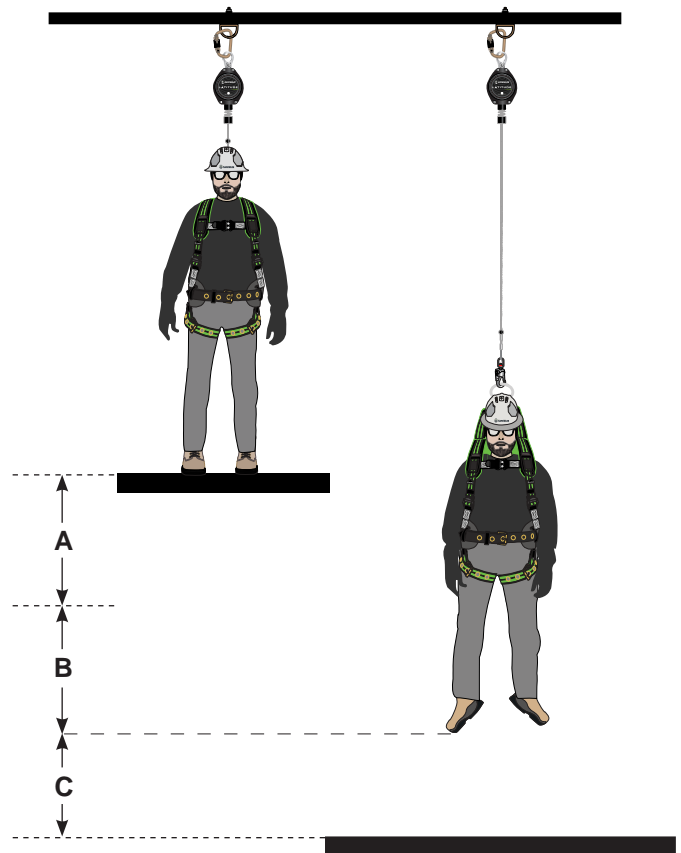
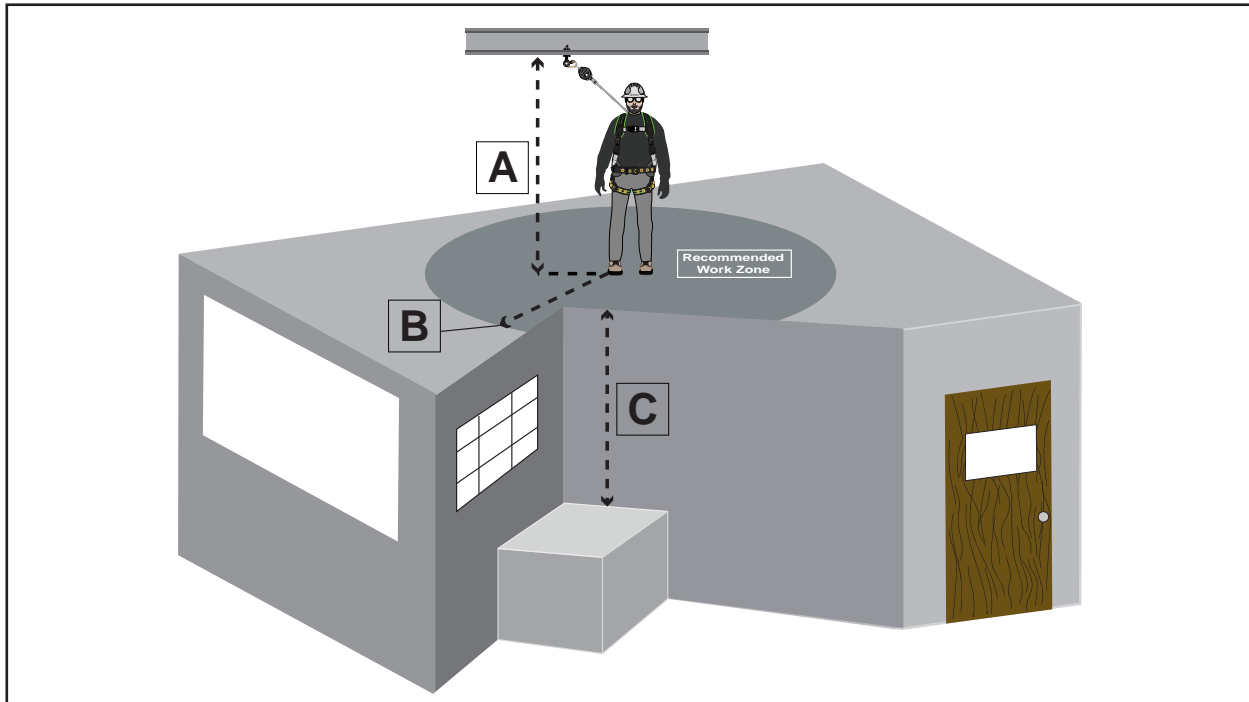

FIGURE 3 - OVERHEAD ANCHORAGE



Latitude HD SRL 130 - 310 lbs (59 - 140 kg)		C							
		<4 ft (1.2 m)	4 ft (1.2 m)	5 ft (1.5 m)	6 ft (1.8 m)	7 ft (2.1 m)	8 ft (2.4 m)	9 ft (2.7 m)	>10 ft (3 m)
A	8 ft (2.4 m)	X	0 ft (0 m)	2.5 ft (0.76 m)	3.9 ft (1.19 m)	5 ft (1.52 m)	6.2 ft (1.88 m)	7.2 ft (2.19 m)	8.2 ft (2.50 m)
	10 ft (3 m)	X	0 ft (0 m)	3.3 ft (1 m)	4.8 ft (1.46 m)	6 ft (1.83 m)	7.3 ft (2.22 m)	8.4 ft (2.56 m)	9.5 ft (2.90 m)
	20 ft (6.1 m)	X	0 ft (0 m)	5.5 ft (1.67 m)	7.9 ft (2.41 m)	9.8 ft (2.98 m)	11.5 ft (3.50 m)	13 ft (3.96 m)	14.4 ft (4.38 m)
	30 ft (9.1 m)	X	0 ft (0 m)	7.1 ft (2.16 m)	10.2 ft (3.10 m)	12.5 ft (3.81 m)	14.6 ft (4.45 m)	16.4 ft (4.99 m)	18.2 ft (5.54 m)
	50 ft (15.2 m)	X	0 ft (0 m)	9.6 ft (2.92 m)	13.5 ft (4.11 m)	16.7 ft (5.09 m)	19.2 ft (5.85 m)	21.7 ft (6.61 m)	23.9 ft (7.28 m)
	70 ft (21.3 m)	X	0 ft (0 m)	11.6 ft (3.54 m)	16.3 ft (4.96 m)	20 ft (6.09 m)	23.1 ft (7.04 m)	26 ft (7.92 m)	29 ft (8.83 m)
		B							

Latitude HD SRL 310 - 420 lbs (140 - 191 kg)		C					
		<6 ft (1.8 m)	6 ft (1.8 m)	7 ft (2.1 m)	8 ft (2.4 m)	9 ft (2.7 m)	>10 ft (3 m)
A	8 ft (2.4 m)	X	0 ft (0 m)	2.5 ft (0.76 m)	3.9 ft (1.19 m)	5 ft (1.52 m)	6.2 ft (1.88 m)
	10 ft (3 m)	X	0 ft (0 m)	3.3 ft (1 m)	4.8 ft (1.46 m)	6 ft (1.83 m)	7.3 ft (2.22 m)
	20 ft (6.1 m)	X	0 ft (0 m)	5.5 ft (1.67 m)	7.9 ft (2.41 m)	9.8 ft (2.98 m)	11.5 ft (3.50 m)
	30 ft (9.1 m)	X	0 ft (0 m)	7.1 ft (2.16 m)	10.2 ft (3.10 m)	12.5 ft (3.81 m)	14.6 ft (4.45 m)
	50 ft (15.2 m)	X	0 ft (0 m)	9.6 ft (2.92 m)	13.5 ft (4.11 m)	16.7 ft (5.09 m)	19.2 ft (5.85 m)
	70 ft (21.3 m)	X	0 ft (0 m)	11.6 ft (3.54 m)	16.3 ft (4.96 m)	20 ft (6.09 m)	23.1 ft (7.04 m)
		B					

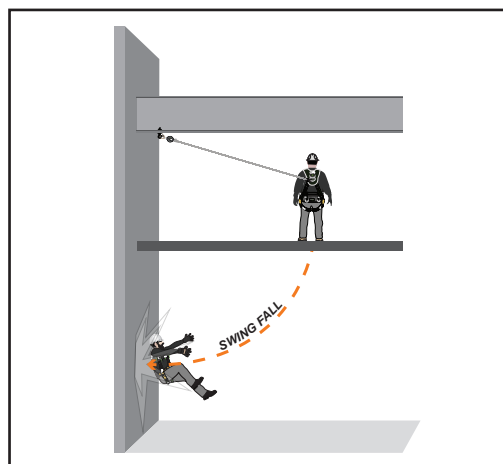

3.0 Swing Falls An anchorage point located in a position that is not directly over the user's fall location results in a Swing Fall (See Figure 4). Swing falls may result in the user striking an object with enough force to cause serious injury. Greater clearance is needed to ensure safety during a swing fall as vertical fall distance will be greater than a fall originating directly below the anchorage point. For help determining additional required fall clearance due to Swing Fall, see (Table 4) on (Page 7) of this manual.

FIGURE 4 - SWING FALLS



Swing Fall Calculation Chart

TABLE 4 - ADDITIONAL FALL CLEARANCE FOR SWING FALL HAZARDS

 Allowable Work Zone	 Allowable Work Zone with Enhanced Caution	 Not Allowed
<p>Using Table 4: Table 4 provides the ability for the user to determine additional fall clearance requirements if a Swing Fall Hazard is present. The Green Cell bordered in White at the center of the Table represents the Dorsal D-ring of the user's Full Body Harness (FBH). This cell is the intersection of the X and Y axes.</p>		
<p>Example 1 - Latitude HD SRL Anchored Overhead: Example 1 represents the user anchored 4' Overhead (Up along the Y Axis) and 4' Laterally (Along the X Axis). The intersection of these distances on the chart indicate an additional 2' of fall clearance required. This additional required fall clearance must be added to the total fall clearance calculation in Figure 2 on Page 5.</p>		
<p>Example 2- Latitude HD SRL Anchored Below Dorsal D-ring: Example 2 represents the user anchoring the Latitude HD SRL to an anchor point 3' below the height of the Dorsal D-ring (Down along the Y Axis) and 5' Laterally (Along the X Axis). The intersection of these distances on the chart indicate an additional 5' of fall clearance required. It also indicates that this configuration is outside of the allowable use. In this case the Lateral Distance must be shortened in order to safely use the Latitude HD SRL.</p>		

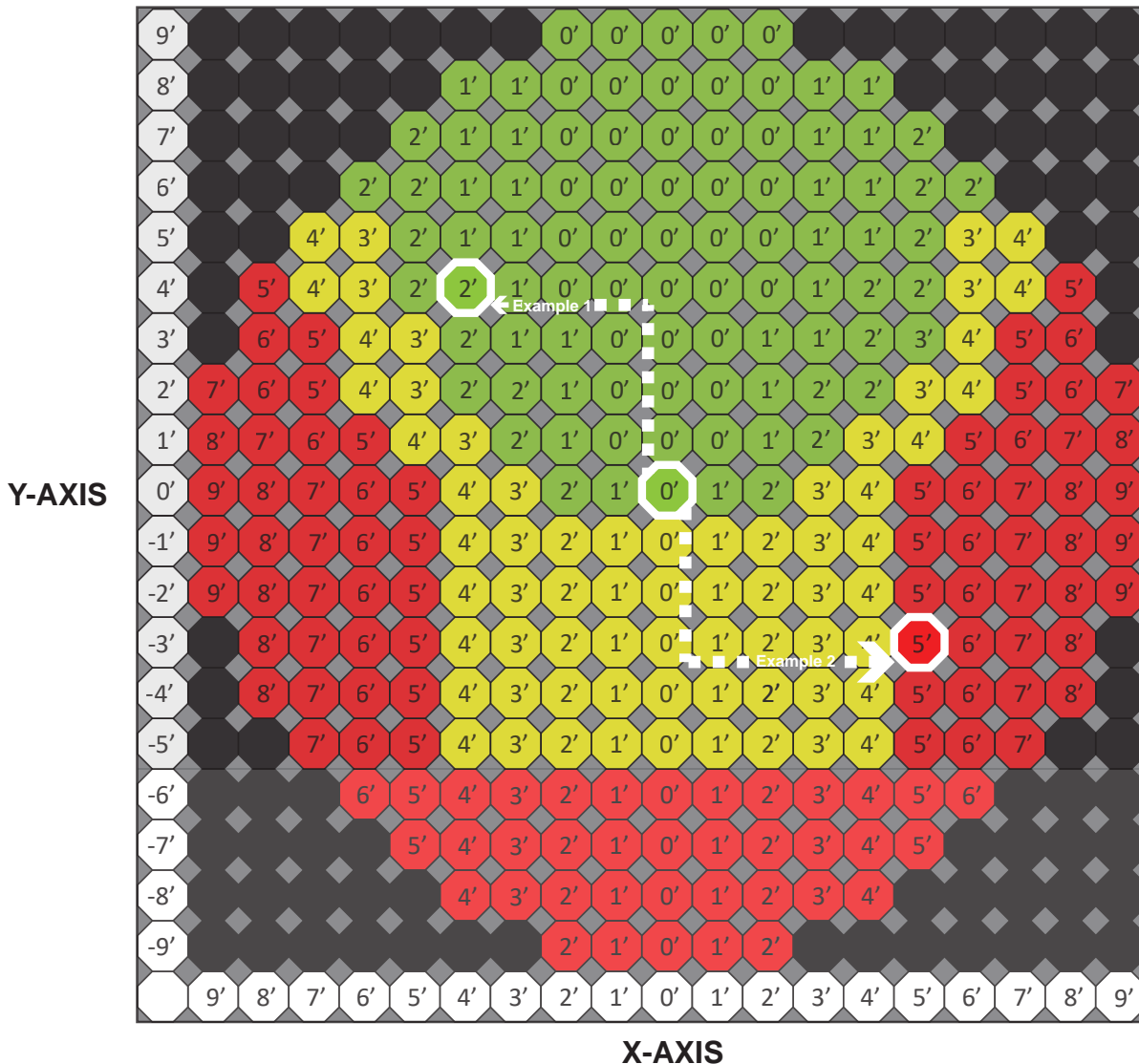

Latitude HD 7' Web: Class A/B

FIGURE 5

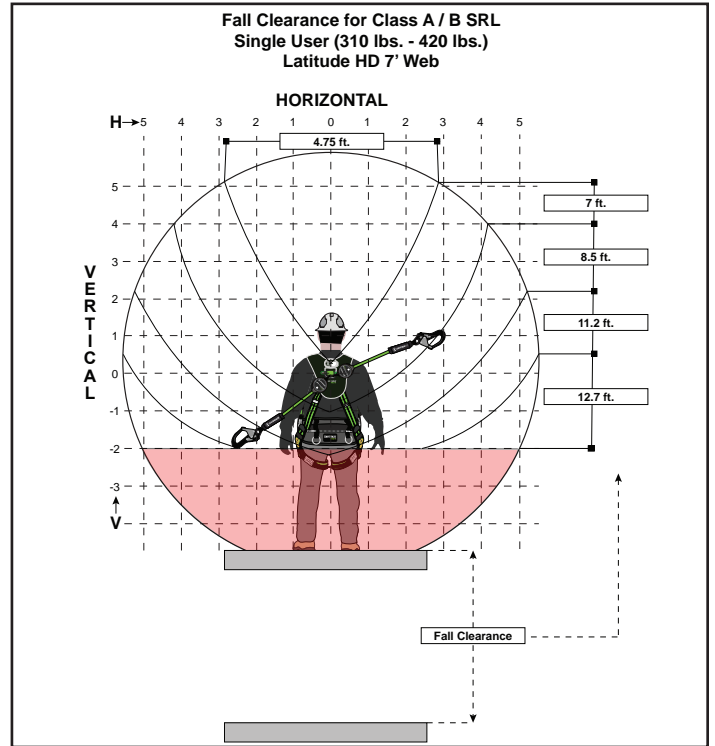
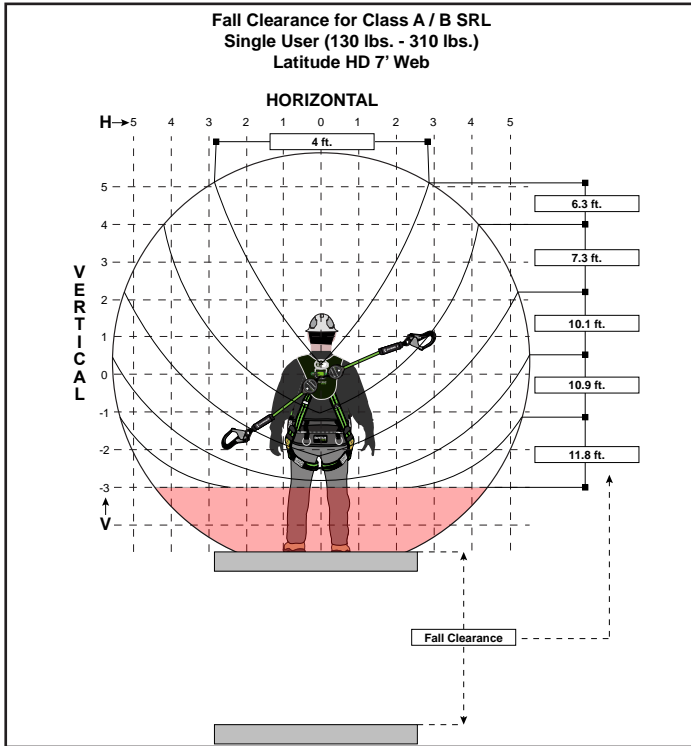

Latitude HD 9' Web: Class A/B

FIGURE 6

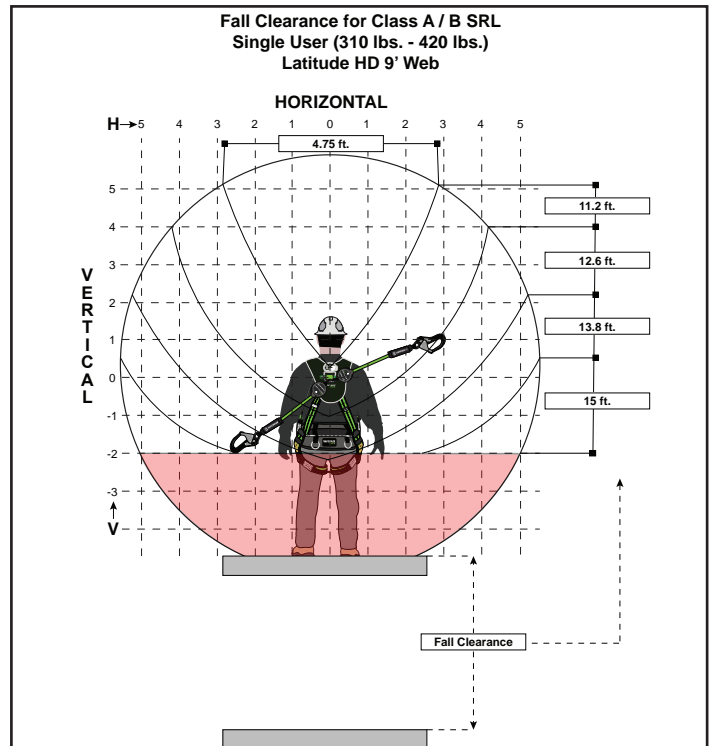
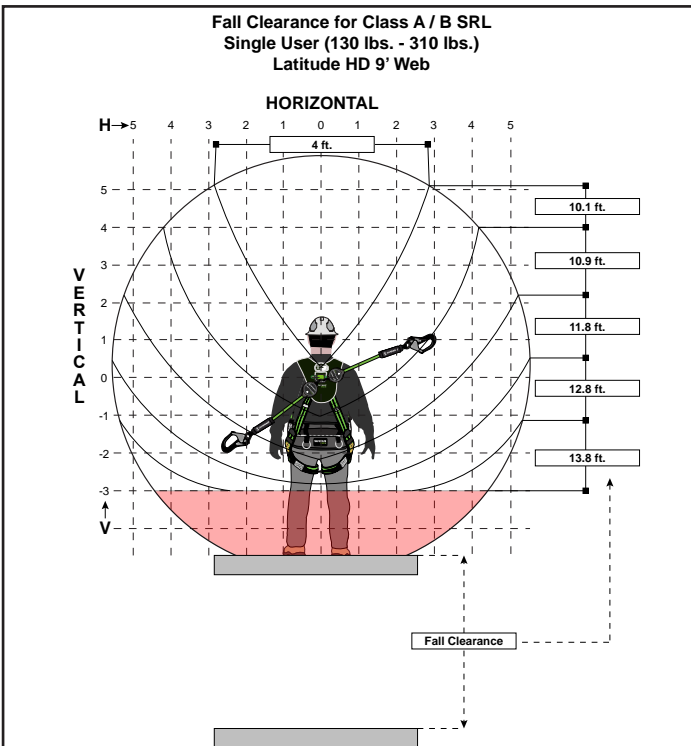

FIGURE 7

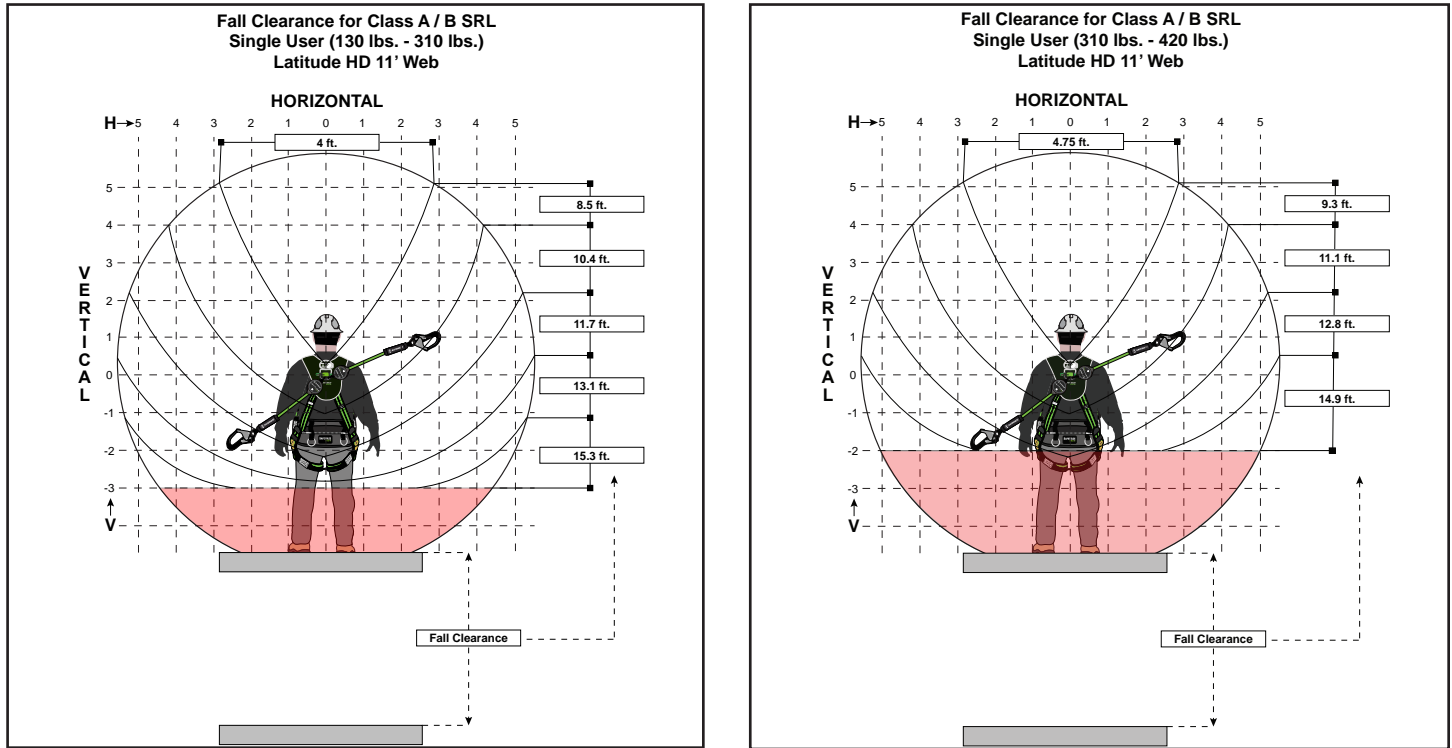

FIGURE 8

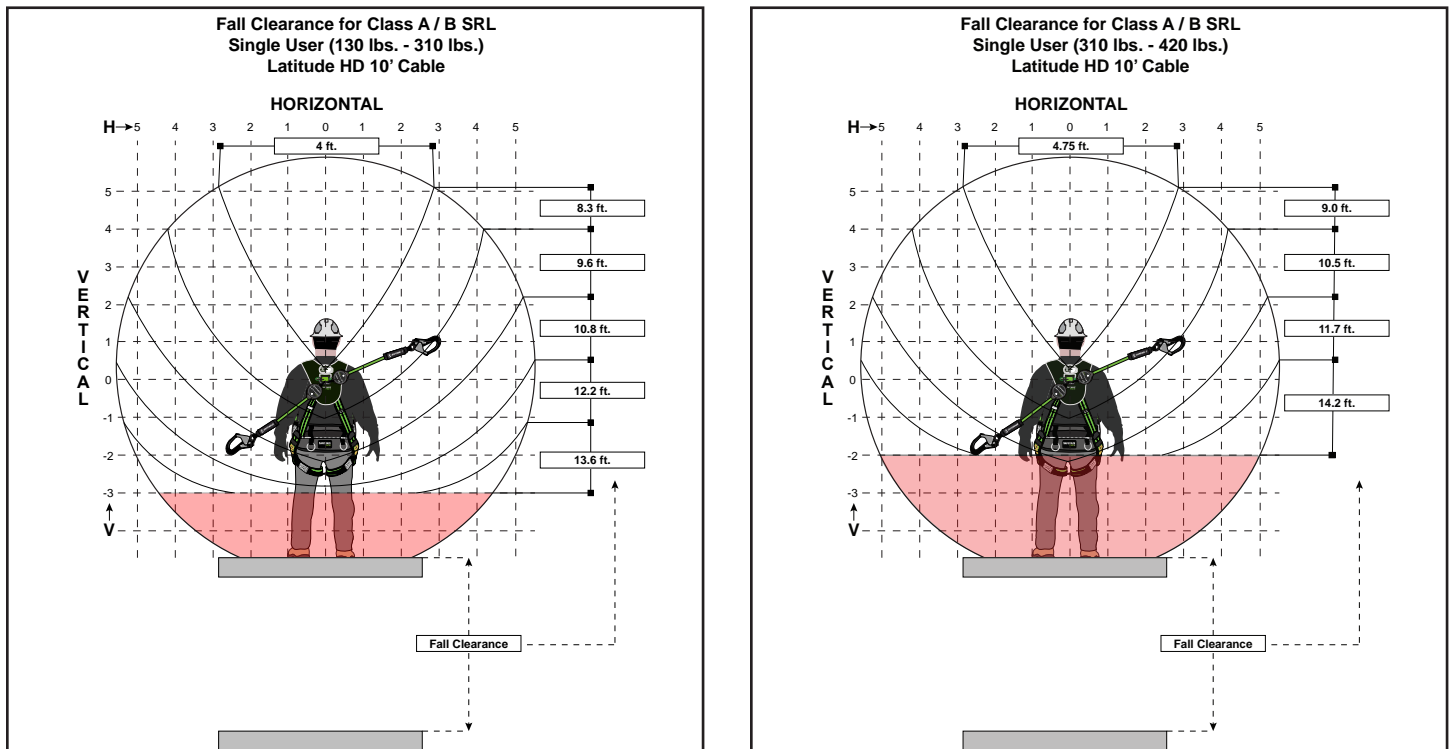
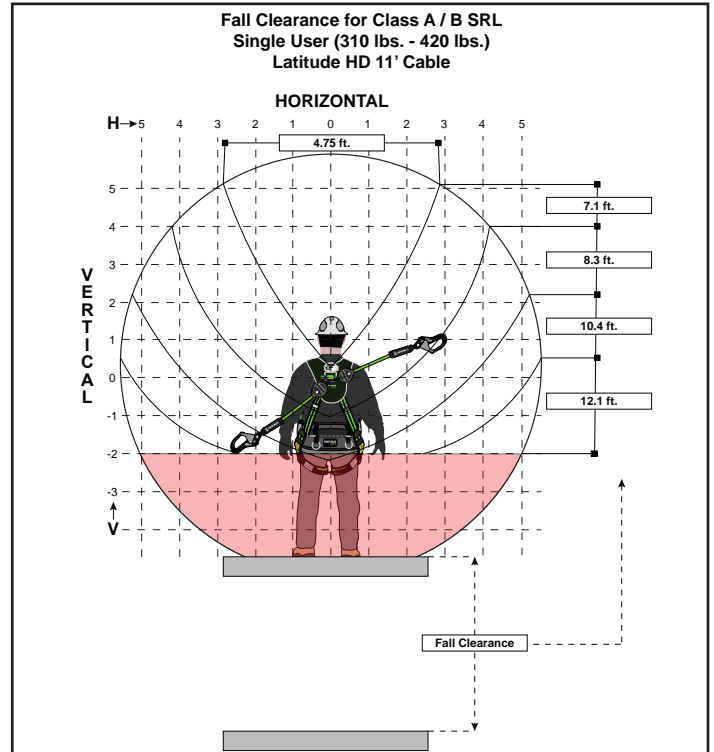
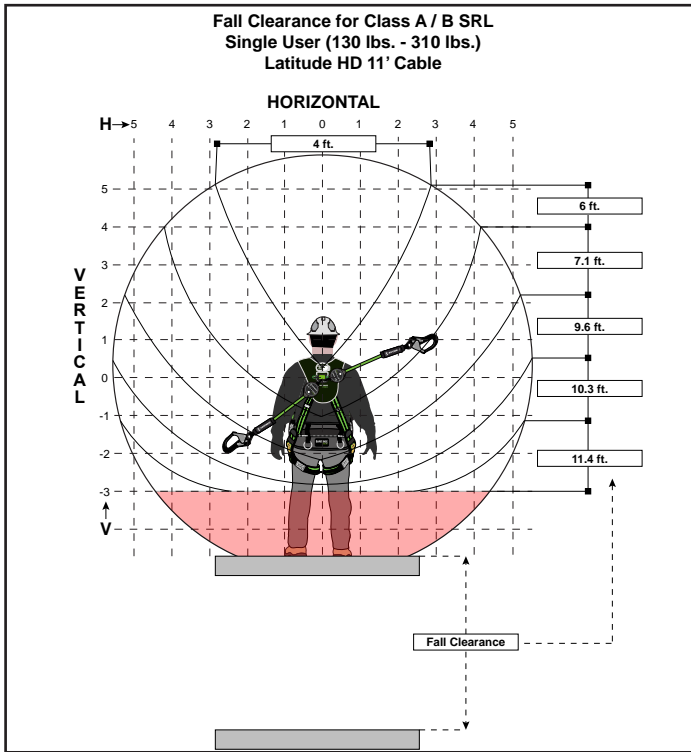
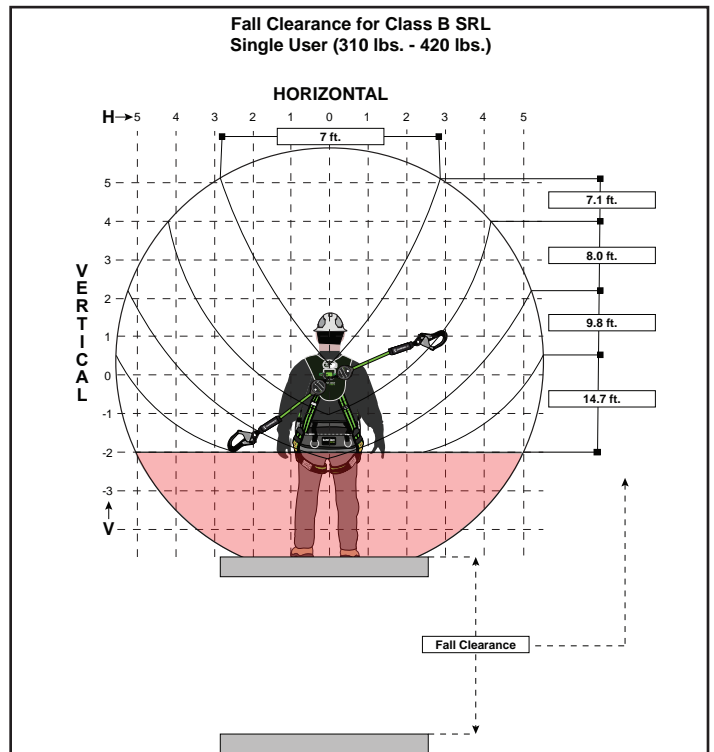
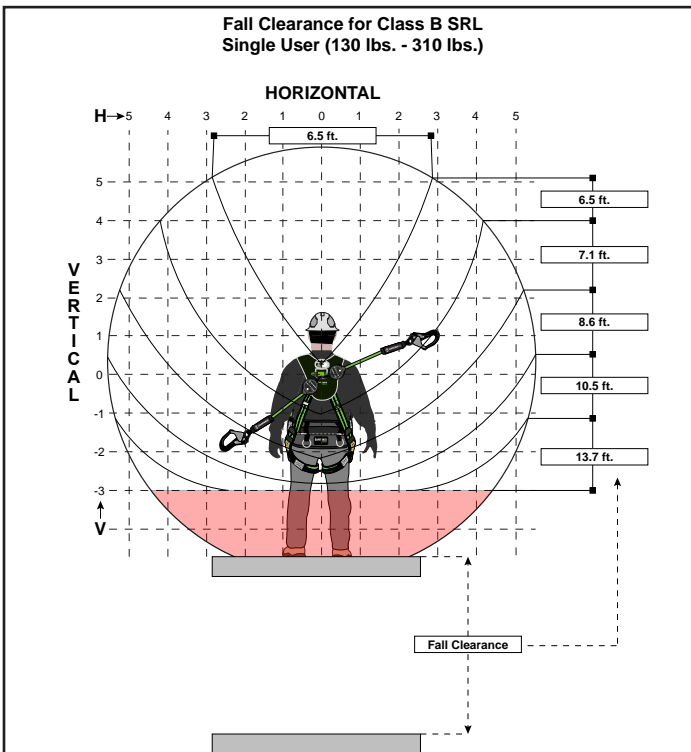

FIGURE 9



Class B SRL's

FIGURE 10



3.1 TIE-BACK OPTIONS

Tie-Back Snap Hooks operate in the same manner as standard double locking snap hooks. The gate is rated at 5,000 lbs, allowing the unit to be tied back into the webbing extension of the SRL. Grip the hook in one hand. Use the thumb and index finger to squeeze the locking mechanism and gate latch, to open the gate as shown in Figure 11. Lessen finger pressure and the gate will close.

To attach to an anchor point, wrap the Tie-Back portion of the lifeline around an approved anchor, then open the gate of the Tie-Back snap hook and pass the web portion of the lifeline through the snap hook. Ensure that the lifeline only passes through the hook once. Ensure that the Tie-Back portion of the lifeline is captured and the gate closes completely (see Figure 11).

FIGURE 11 - TIE-BACK EXAMPLES

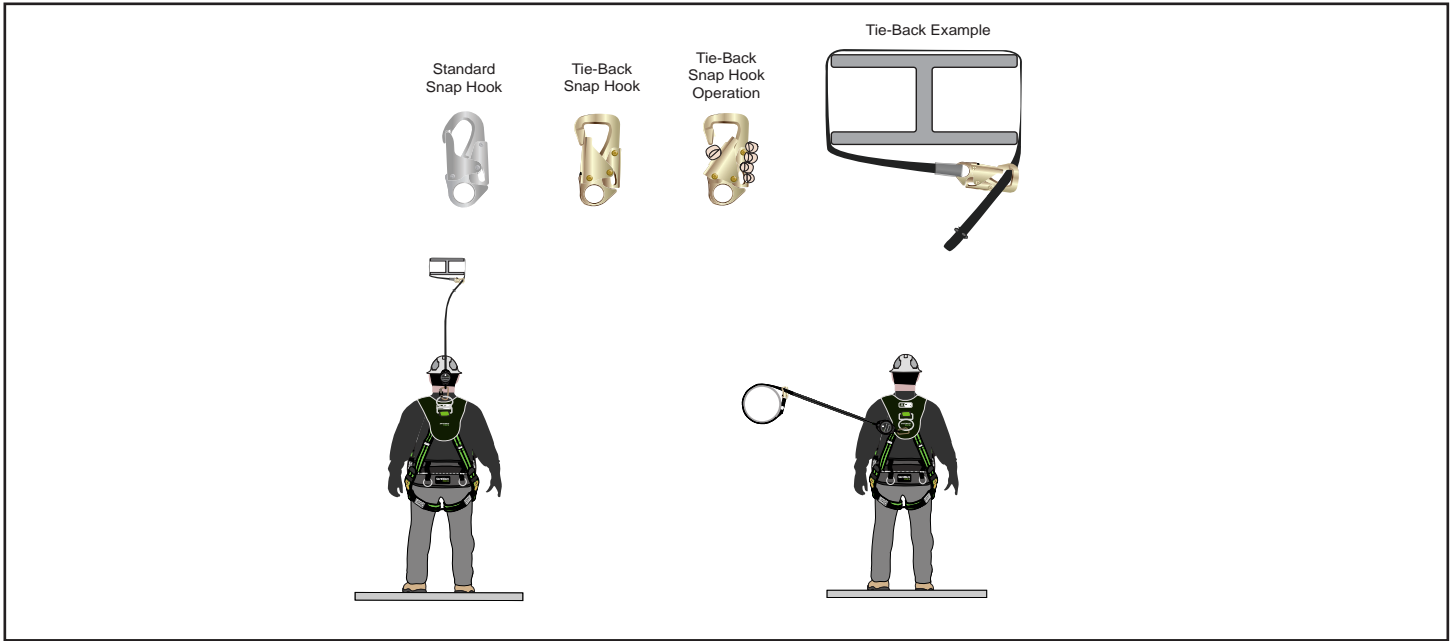

FIGURE 12 - TIE-BACK SYSTEM CONNECTIONS



WARNING: Only the Tie-Back hook may be used to snap back onto the Tie-Back portion of the SRL Lifeline. When installed, the Tie-Back hook must contact the heavy web section. If the anchor structure is so large that the Tie-Back hook contacts the lifeline above the Tie-Back portion of the lifeline, a different anchor structure must be used.

A: TIE BACK ANCHORAGE	
17" CIRCUM. OF STRUCTURE	
FREE FALL	ANCHORAGE DISTANCE ABOVE OR BELOW D-RING
0 ft	5 ft.
0 ft	4 ft.
0 ft	3 ft.
0 ft	2 ft.
0 ft	1 ft.
.5 ft	0 ft.
1.5 ft	-1 ft.
2.5 ft	-2 ft.
3.5 ft	

B: TIE BACK ANCHORAGE	
9.5" CIRCUM. OF STRUCTURE	
FREE FALL	ANCHORAGE DISTANCE ABOVE OR BELOW D-RING
0 ft	5 ft.
0 ft	4 ft.
1 ft	3 ft.
2 ft	2 ft.
3 ft	1 ft.

C: DIRECT ANCHORAGE	
FREE FALL	ANCHORAGE DISTANCE ABOVE OR BELOW D-RING
0 ft	8 ft. —
0 ft	7 ft. —
0 ft	6 ft. —
0 ft	5 ft. —
0 ft	4 ft. —
0 ft	3 ft. —
0 ft	2 ft. —
1 ft	1 ft. —
2 ft	0 ft. —

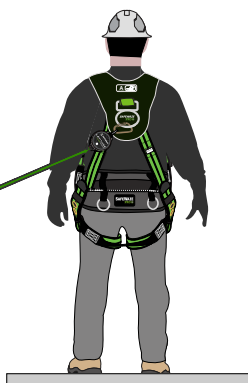

3.2 COMPATIBILITY OF COMPONENTS

Unless otherwise noted, Safewaze equipment is designed for use with Safewaze approved components and subsystems only. Substitutions or replacements made with non approved components or subsystems may jeopardize compatibility of equipment and may affect safety and reliability of the complete system.



IMPORTANT: Read and follow manufacturer's instructions for associated components and subsystems in your personal fall arrest system.

3.3 COMPATIBILITY OF CONNECTORS

Connectors are compatible with connecting elements when they have been designed to work together in such a way that their sizes and shapes do not cause their gate mechanisms to inadvertently open, regardless of how they become oriented. Connectors (hooks, carabiners, and D-rings) must be capable of supporting at least 5,000 lbs. (22.2 kN). Connectors must be compatible with the anchorage or other system components (see Figure 13). Do not use equipment that is not compatible. Non-compatible connectors may unintentionally disengage (see Figure 13). Connectors must be compatible in size, shape, and strength. Self-locking snap hooks and carabiners are required by ANSI Z359 and OSHA guidelines. Contact Safewaze if you have any questions about compatibility.



NOTE: SOME SPECIALTY CONNECTORS HAVE ADDITIONAL REQUIREMENTS. CONTACT SAFEWAZE WITH QUESTIONS.

FIGURE 13 - UNINTENTIONAL DISENGAGEMENT

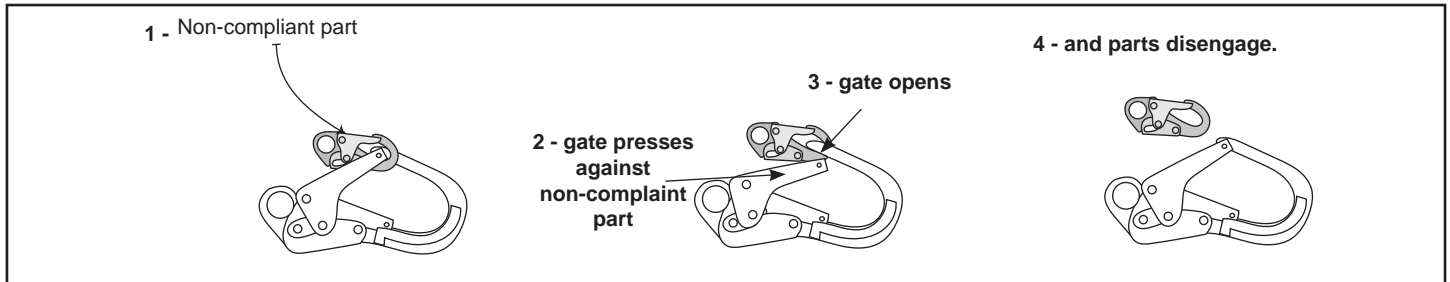

Using a connector that is undersized or irregular in shape (1) to connect a snap hook or carabiner could allow the connector to force open the gate of the snap hook or carabiner. When force is applied, the gate of the hook or carabiner presses against the non-compliant part (2) and forces open the gate (3). This allows the snap hook or carabiner to disengage (4) from the connection point.

3.4 MAKING CONNECTIONS

Snap hooks and carabiners used with this equipment must be double locking and/or twist lock. Ensure all connections are compatible in size, shape and strength. Do not use equipment that is not compatible. Ensure all connectors are fully closed and locked.

Safewaze connectors (snap hooks and carabiners) are designed to be used only as specified in each product's user's instructions. (See Figure 14) for examples of inappropriate connections. Do not connect snap hooks and carabiners:

- To a D-ring to which another connector is attached.
- In a manner that would result in a load on the gate (with the exception of Tie-Back hooks). NOTE: Large snap hooks must not be connected to objects which will result in a load on the gate if the hook twists or rotates, unless the snap hook complies with ANSI Z359.12 and is equipped with a 3,600 lb (16 kN) gate. Check the marking on your snap hook to verify its compatibility.



NOTE: Large throat snap hooks must not be connected to standard size D-rings or similar objects which will result in a load on the gate if the hook or D-ring twists or rotates, unless the snap hook complies with ANSI Z359.12 and is equipped with a 3,600 lb (16 kN) gate. Check the marking on your snap hook to verify that it is appropriate for your application.

- In a false engagement, where features that protrude from the snap hook or carabiner catch on the anchor, and without visual confirmation seems to be fully engaged to the anchor point.
- To each other.
- By wrapping the web lifeline around an anchor and securing to lifeline except as allowed for Tie-Back models (see Section 3.0).
- To any object which is shaped or sized in a way that the snap hook or carabiner will not close and lock, or that roll-out could occur.
- In a manner that does not allow the connector to align properly while under load.

FIGURE 14 - INAPPROPRIATE CONNECTIONS

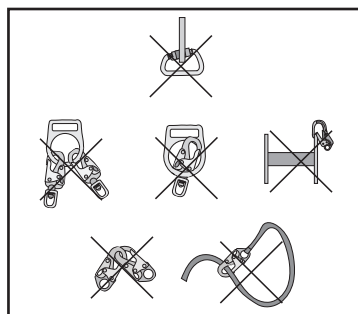

4.0 INSTALLATION

4.1 PLANNING

Plan your fall protection system before starting your work. Account for all factors that may affect your safety before, during, and after a fall. Consider all requirements and limitations defined in Section 2.

4.2 HARNESS MOUNTING WITH BEHIND THE WEB BRACKET

The Behind the Web Bracket comes fully assembled and ready for installation. No tools are required for installation of the bracket onto harness. Use the following instructions and Figure 15 to install the bracket:

To Fasten To Harness:

1. Unfasten the two small brackets on the green retractable spacer off of the carabiner.
2. Slide the green spacer around to the side of carabiner to allow opening of the carabiner gate.
3. Open the carabiner gate and slide spacer off of carabiner and remove one of the retractables.
4. Holding gate open on carabiner, insert the open end of carabiner through the webbing loops at Dorsal D-ring on the X Pad of harness. Ensure that both loops of webbing on X Pad are inside of carabiner.
5. With carabiner gate still open, slide the removed retractable and green spacer back onto carabiner and allow carabiner gate to close.
6. Slide the green retractable spacer back over the gate of carabiner and snap the two small brackets back into place on carabiner, with the web loops positioned between these two small brackets.

FIGURE 15 - BEHIND THE WEB BRACKET INSTALLATION

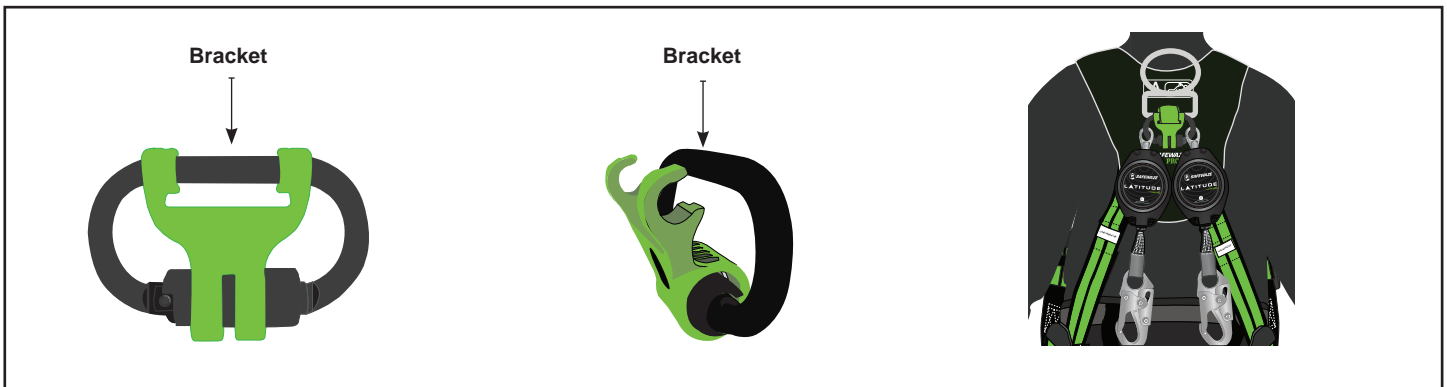

4.3 HARNESS MOUNTING WITH SW-9012 BEHIND THE WEB BRACKET

The D-ring brackets comes fully assembled and ready for installation. No tools are required for installation of the bracket onto harness. Use the following instructions and Figure 16 to install the SW-9012 Behind the Web Bracket. Figure 17 illustrates the Carabiner w/Dual Bracket which simply utilizes a double locking carabiner to attach the bracket to the Dorsal D-ring of the harness:

To Fasten To Harness:

1. Ensure that the curved portion of SW-9012 is in a downward orientation relative to the harness (See Dwg. 1, Figure 16).
2. Simultaneously depress both locking buttons (A) and (B) (See Dwg. 2, Figure 16) and slide the bracket open as indicated (See Dwg. 3, Figure 16).
3. With the bracket open, install dual leg retractables onto the bracket via the swivel tops of each. Swivels should be hanging on the curved portion of bracket.
4. While pressing in on locking button (A) slide the bar behind both loops of webbing at dorsal D-ring until the bar locks back into place.
5. Check the locking function of the bracket by attempting to slide the bracket open WITHOUT depressing locking buttons (A) or (B). Bracket bar should not move and the bracket is now locked into place.

FIGURE 16 - SW-9012 DUAL BRACKET INSTALLATION

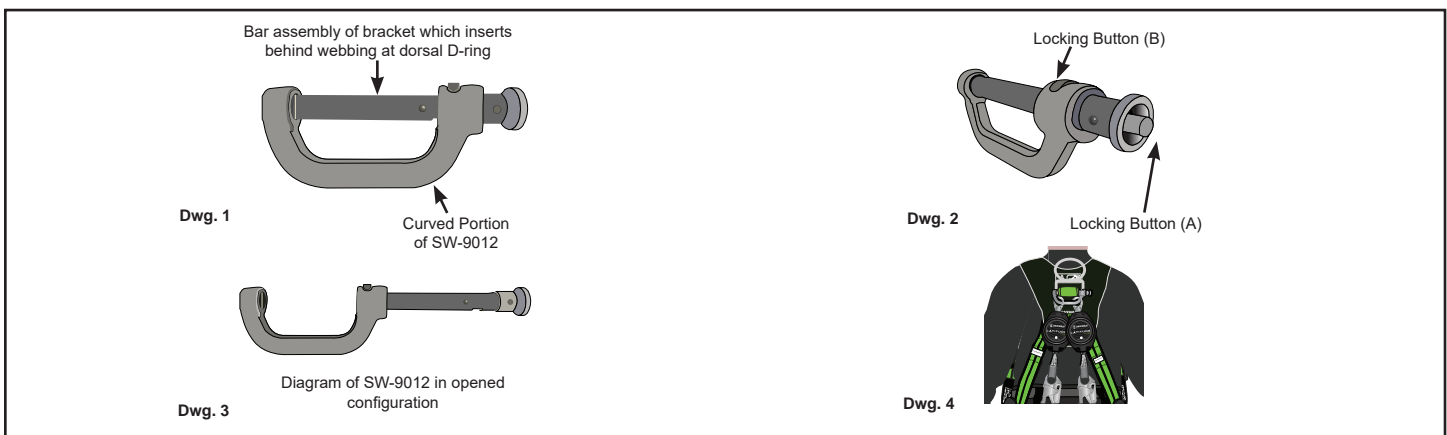

**FIGURE 17 - CARABINER W/DUAL BRACKET
INSTALLATION**

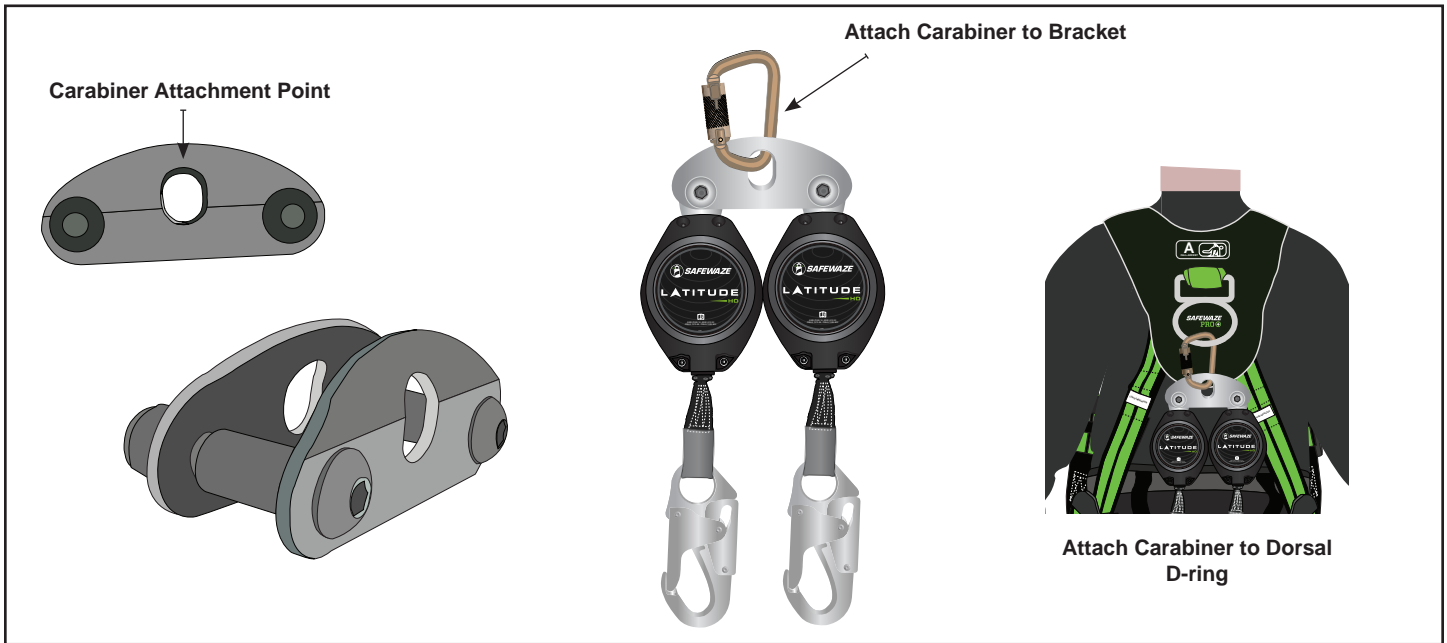

4.4 HARNESS MOUNTING WITH 9013 BEHIND THE WEB BRACKET

The 9013 Behind the Web Bracket comes fully assembled and ready for installation. No tools are required for installation of the bracket onto harness. Use the following instructions and Figure 18 to install the 9013 Behind the Web Bracket.

To Fasten To Harness:

1. Ensure that the curved portion of 9013 is in a downward orientation relative to the harness (See Dwg. 1, Figure 18).
2. Simultaneously depress both locking button (A) and and slide lock (B) (See Dwg. 2) to swing the bracket open as indicated (See Dwg. 3, Figure 18).
3. With the bracket open, install dual leg retractables onto the bracket via the swivel tops of each. Swivels should be hanging on the curved portion of bracket.
4. Slide the bar behind both loops of webbing at dorsal D-ring. Swing the bracket closed until it locks into place.
5. Check the locking function of the bracket by attempting to swing the bracket open WITHOUT depressing locking button (A) or slide lock (B). Bracket bar should not move and the bracket is now locked into place (See Dwg. 4, Figure 18).
6. Dual leg Retractable can be easily installed and removed from bracket by once again depressing both locking button (A) and slide lock (B), which allows bracket to swing open without complete removal from harness.

FIGURE 18 - 9013 DUAL BRACKET INSTALLATION

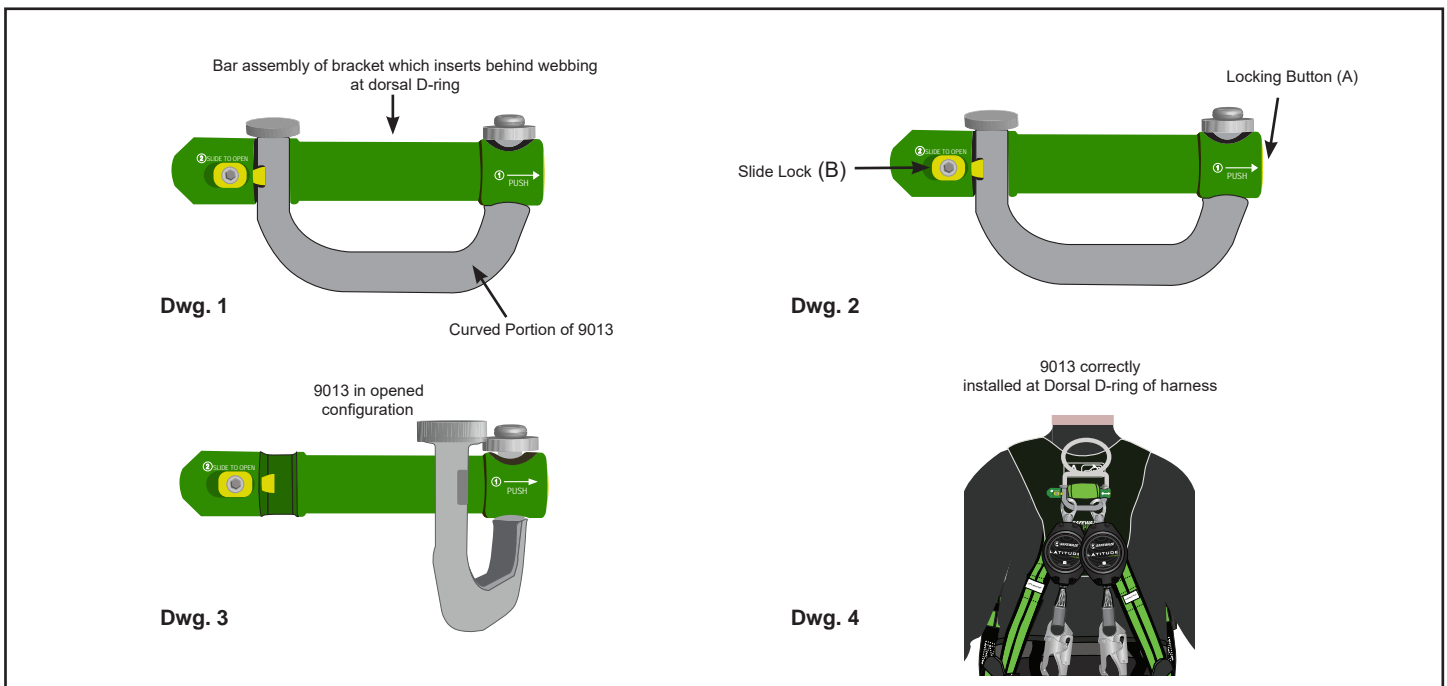

5.0 USE



WARNING: Contact Safewaze if you have questions, regarding compatibility of this equipment, that are not covered in this manual. Do not alter or misuse this equipment. Some subsystem components could affect the performance of the operation of this equipment. Do not anchor this product to moving machinery, hazards that include chemical, electrical or gaseous characteristics. Failure to comply with this warning could result in injury or death.



WARNING: Consult your doctor if there is reason to doubt your fitness to safely absorb the shock from a fall arrest. Age and fitness seriously affect a worker's ability to withstand falls. Pregnant women or minors must not use Safewaze SRL's. Failure to heed this warning may result in serious injury or death.

5.1 OPERATION

Inspect the SRL, as described in Section 8, before using the equipment. Refer to Figure 19 for common system connections used with SRL applications. Depending on the SRL model, mount the SRL either to an approved anchor point or on the back of a Full Body Harness as described in Section 2.0. Connect the snap hook, carabiner or Tie-Back attachment to a suitable anchorage. Ensure connections are compatible in size, shape, and strength. Ensure hooks are fully closed and locked. When the worker is fully attached, the worker is then free to move about within the recommended working area. If a fall occurs, the SRL will lock and arrest the fall. Upon rescue, remove the SRL from use. When working with an SRL, always allow the lifeline to retract back into the device in a controlled manner. Do not release the unit to "free-spin" back into itself.



WARNING: Do not tie or knot the lifeline. Avoid lifeline contact with sharp or abrasive surfaces. Inspect the lifeline frequently for cuts, fraying, burns, or signs of chemical damage. Dirt, contaminants, and water can lower performance of the lifeline. Use caution near power lines. Failure to comply with this warning may result in serious injury or death.

5.2 AFTER A FALL

Equipment exposed to the force of a fall, or that shows damage consistent with the effects of a fall, must be removed from service immediately. Equipment must then be repaired (see Section 7.1) in the correct manner or disposed of (see Section 8.5).

5.3 BODY SUPPORT

A full body harness must be worn when using Safewaze Latitude HD SRL's.



IMPORTANT: Do not use a body belt for free fall applications. See OSHA 1926.502 for guidelines.

5.4 SYSTEM CONNECTIONS

Figure 19 illustrates some typical examples of harness and anchorage connections for Safewaze SRL Fall Arrest Systems. When using a snap hook to make a connection, ensure roll-out cannot occur (see Figure 14). Do not use snap hooks or carabiners that will not completely close over the anchor point. This includes traditional overhead anchor point tie off, housing attachment to dorsal D-ring, and 100% tie off. Follow the manufacturer's instructions supplied with each system component.



WARNING: Never connect the snap hook of one SRL to the lifeline of another SRL or lanyard. Failure to comply with this warning may result in equipment malfunction, serious injury or death.

5.5 ANCHORAGE

Select an anchorage location with minimal free fall and swing fall hazards (see Section 2). Select a rigid anchorage point capable of sustaining static loads as defined in Section 2.2. Where anchoring overhead is not feasible, Safewaze SRL's may be secured to anchorage points below the level of the user's dorsal D-ring, but never below the user's feet. NOTE: THIS ADJUSTMENT WILL ADJUST THE TOTAL FREE FALL AND MAXIMUM ARREST DISTANCE OF A FALL.

FIGURE 19 - SYSTEM CONNECTIONS

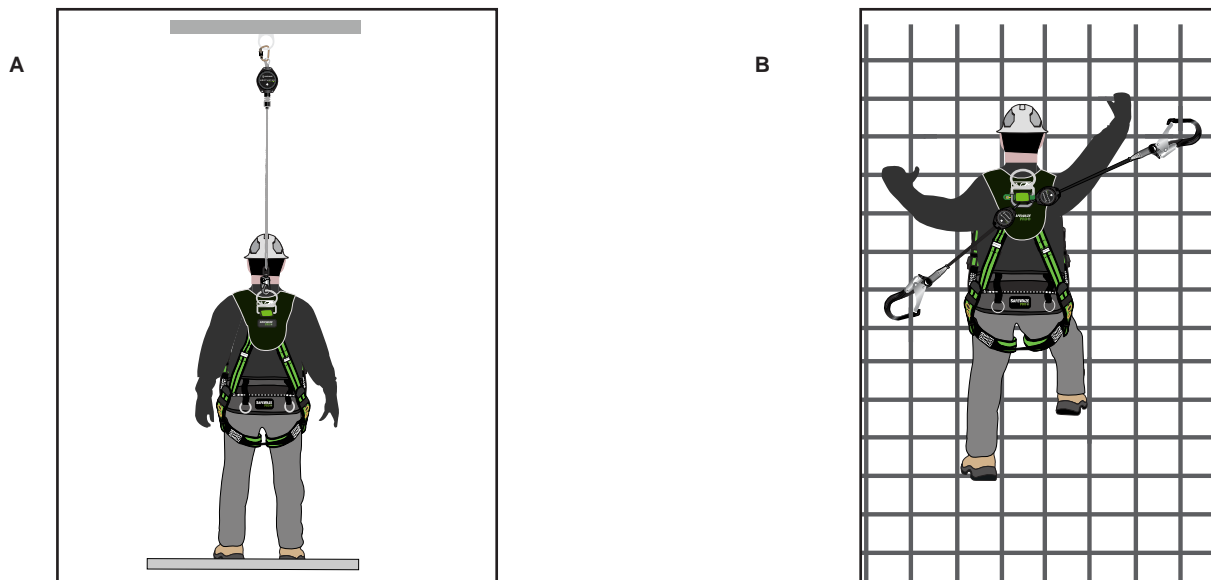

5.6 DUAL LEG SRL

With the Dual Leg Safewaze SRL mounted on the back of a Full Body Harness, the user can have continuous fall protection (100 % tie-off) while ascending, descending, or moving laterally (see Figure 19-B). With the lifeline leg of one SRL attached to an anchorage point, the worker can move to a new location, attach the unused lifeline leg of the other SRL to another anchorage point, and then disconnect from the original anchorage point.



IMPORTANT: Never connect more than one person at a time to the twin-leg system.

IMPORTANT: Do not allow the lifelines to pass under arms or between legs.

6.0 SPECIFICATIONS

6.1 MATERIALS

TABLE 5 - MATERIALS

Housing	Aluminum or Poly	Web	Ultra High Molecular Weight Webbing
Drum	Aluminum Alloy	Dual D-Ring Bracket	Stainless Steel
Fasteners	Zinc Plated Alloy Steel Screws	Motor Spring	Stainless Steel
	Stainless Steel Rivets	Swivel	Zinc Plated Steel
Locking Pawls	Brass	Cable	3/16" Galvanized or Stainless Steel
Main Shaft	Stainless Steel	Tie Back Extension	Polyester
SW-9012 Bracket	Forged Steel	Snap Hook / Rebar Hook	Forged Steel or Aluminum
Dual Bracket BWB	Alloy Steel, Heat Treated w/ Plastic Keeper	9013 Bracket	Forged Steel Gate, Aluminum Barrel

6.2 PERFORMANCE

Safewaze SRL's have been tested and certified to the performance requirements of the standard(s) identified on their ID labels. See Tables 6 and 7 for performance specifications.

6.3 PERFORMANCE SPECIFICATIONS

TABLE 6 - PERFORMANCE SPECIFICATIONS

Item	Length	Class
FS-FSP1211-G	11	A
FS-FSP1211-G-RBH	11	A
FS-FSP1407-W	7	A
FS-FSP1407-W-RBH	7	A
FS-FSP1407-W-TBH	7	A
FS-FSP1409-W	9	A
FS-FSP1409-W-DL	9	A
FS-FSP1409-W-DL-BWB	9	A
FS-FSP1409-W-DL-RBH	9	A
FS-FSP1409-W-DL-RBH-BWB	9	A
FS-FSP1409-W-RBH	9	A
FS-FSP1411-W	11	A
FS-FSP1411-W-RBH	11	A
FS-FSP1411-W-TBH	11	A
FS-FSP14075-W	7	A
FS-FSP14085-W-RBH	7	A
FS-FSP14075-W-TBH	7	A
FS-FSP15075-W-BWB	7	A
FS-FSP15085-W-RBH-BWB	7	A
SW-8008-10	10	A
SW-8008-10-ALU	10	A
SW-8008-10-ALU-DL	10	A
SW-8008-10-ALU-RBH	10	A
SW-8008-10-ALU-RBH-DL	10	A
SW-8008-10-DL	10	A
SW-8008-10-RBH	10	A
SW-8008-10-RBH-DL	10	A
FS-FSP14095-W	11	A
FS-FSP14095-W-RBH	11	A

6.4 MAXIMUM ARREST FORCE AND MAXIMUM ARREST DISTANCE

SRL's documented in this instruction manual meet the following Arrest Force and Arrest Distance maximums when tested in accordance with Section 4.2.1 of ANSI Z359.14.

TABLE 7 - CLASS A

Average Arresting Force	≤ 1,350 lbs (6.0kN)
Maximum Arresting Force	≤ 1,800 lbs (8.0 kN)
Maximum Arrest Distance	24 in (0.61 m)

TABLE 7 - CLASS B

Average Arresting Force	≤ 900 lbs (5.0kN)
Maximum Arresting Force	≤ 1,800 lbs (8.0 kN)
Maximum Arrest Distance	54 in (1.37 m)

7.0 MAINTENANCE, SERVICING, AND STORAGE

7.1 SERVICE

Remove the SRL from use if the SRL has been subjected to fall arrest forces or inspection reveals an unsafe or defective condition. If unrepairable Dispose of the SRL as recommended in Section 8.5.

7.2 CLEANING

Cleaning procedures for Safewaze SRL's are as follows:

Periodically clean the exterior of the SRL using water and a mild soap solution. Clean labels to maintain readability.

An excessive buildup of debris on the cable/web may prevent the cable lifeline from fully retracting back into the housing and create a potential free fall hazard.

Clean webbing using water and a mild soap solution. Allow to dry fully before using or allowing web to fully retract into housing.

Clean cable using an acid-free oil or petroleum jelly at regular intervals. Always wear gloves when servicing/inspecting steel cable SRL's.



IMPORTANT: If the lifeline comes in contact with acids or other caustic chemicals, remove the SRL from service and wash with water and a mild soap solution. Inspect the SRL (using the Inspection Checklist on Page 20) before returning to service.

7.3 STORAGE

Store Safewaze SRL's in a cool, dry, clean environment out of direct sunlight. Avoid areas where chemical vapors may exist. Thoroughly inspect the SRL after any period of extended storage.

8.0 INSPECTION

8.1 BEFORE EACH USE

Before each use ensure that the equipment is in good working condition. Inspect the unit to ensure it has not been damaged and that the unit pays out and retracts properly. Prior to each use, the braking system must be inspected. Grasp the body of the unit in one hand and the cable/web in the other. With a quick, jerking motion, pull down on the web/cable. The brake should engage, stopping movement almost immediately. Inspect the webbing and/or cable (using "Inspection Checklist" Page 20) and ensure that all connection hardware is working properly. Brake failure or unsatisfactory results during any portion of the inspection, require immediate removal of the SRL from service. Figure 21 points out key inspection areas of the Latitude HD series of SRL's.

8.2 INSPECTION FREQUENCY

The Safewaze SRL - must be inspected at the intervals defined in Section 2.3. Inspection procedures are described in the "Inspection Checklist" (see Page 20). Annual inspections by a Competent Person other than the user must be recorded in the Inspection Log on (Page 22) of this manual.

8.3 UNSAFE OR DEFECTIVE CONDITIONS

Figure 22 shows examples of equipment damage. Equipment inspectors must be trained to look for damage as illustrated in (Figure 22), as well as other damage that may occur. If inspection reveals an unsafe or defective condition remove the SRL from service.

8.4 PRODUCT LIFE

The working life of Safewaze SRL's is determined by work conditions, care and inspection provided. As long as the SRL passes inspection, it may remain in service.

8.5 DISPOSAL

Dispose of the Safewaze SRL if it has been damaged by fall arrest forces or inspection reveals an unsafe or defective condition that cannot be repaired by an authorized Safewaze Service Center. Before disposing of the SRL, cut the cable/web lifeline in half so that it is not mistakenly reused.

FIGURE 21 - INSPECTION DIAGRAMS

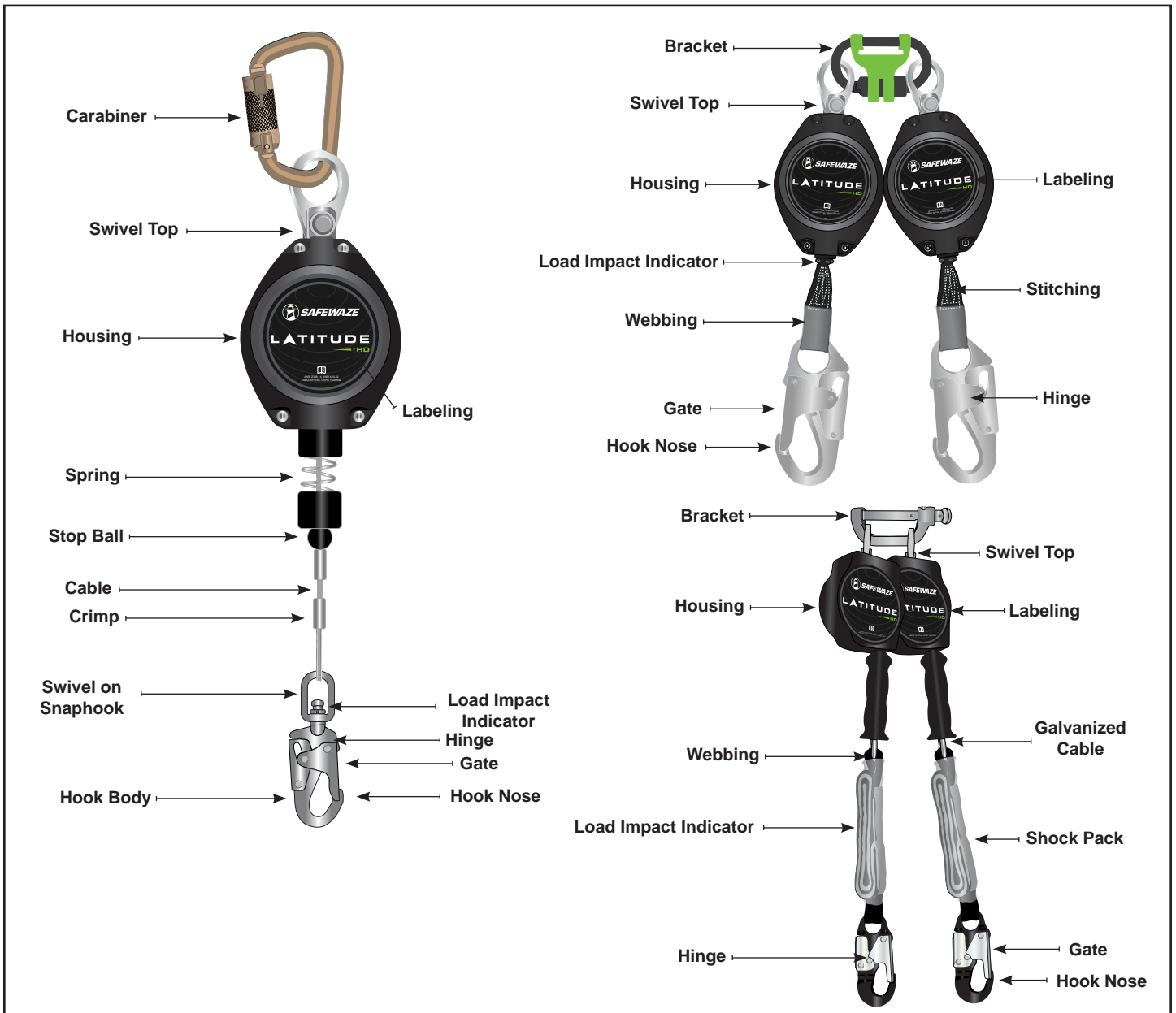
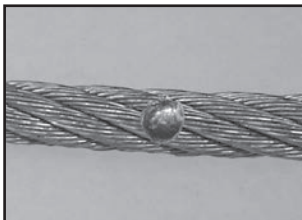

FIGURE 22 - EXAMPLES OF EQUIPMENT DAMAGE

Cable Damage Examples



Kinked Wire Rope



Welding Spatter

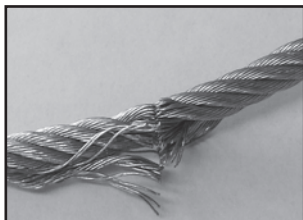

Broken Wires



Bird-Caging

Webbing Damage Examples

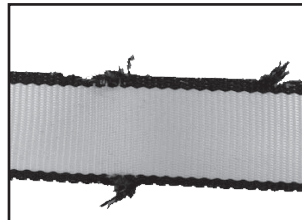

Frayed

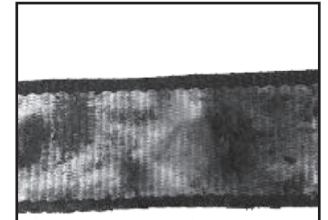

Heavily Soiled

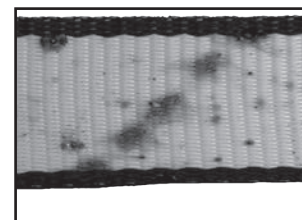

Welding Burns

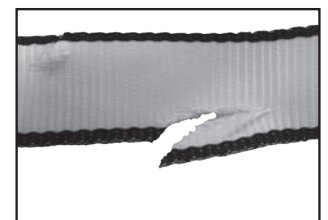

Cut

Inspection Checklist - Fall Protection Equipment

Retractable Lifeline

Description:		Model #:	
Serial #:		Date of Manufacture:	
Inspector:		Date Inspected:	
Description	Pass <input checked="" type="checkbox"/>	Fail <input checked="" type="checkbox"/>	Comments
Main Unit	Webbing or Cable		
	Stitching or Crimp		
	Stop Ball (cable only)		
	Spring (cable only)		
	Housing		
	Labeling or Engraving		
	Swivel Top		
Hooks & Carabiners	Swivel on Snaphook (cable only)		
	Hook Body		
	Hook Nose		
	Load Impact Indicator		
	Gate (keeper)		
	Hinge (at gate)		
	Bracket (dual only)		
Tests	Carabiner		
	Retraction & Tension Braking Test		
<input checked="" type="checkbox"/> PASS: Initial _____		<input checked="" type="checkbox"/> FAIL: Initial _____	
Inspector Signature:			

SERIAL NUMBER:			
MODEL NUMBER:			
DATE OF PURCHASE:			
INSPECTION DATE	NOTES	CORRECTIVE ACTION	MAINTENANCE PERFORMED
APPROVED BY:			
APPROVED BY:			
APPROVED BY:			
APPROVED BY:			
APPROVED BY:			
APPROVED BY:			
APPROVED BY:			
APPROVED BY:			
APPROVED BY:			



SAFEWAZE

**Safewaze
225 Wilshire Ave SW
Concord, NC 28025**

**PHONE: 1-800-230-0319
FAX: 1-704-262-9051**

**WEB: safewaze.com
EMAIL: info@safewaze.com**